



ILMK 351

Screw-in Transmitter

Ceramic Sensor

accuracy according to IEC 60770:
standard: 0.35% FSO
option: 0.25% FSO

Nominal pressure

from 0 ... 40 mbar up to 0 ... 20 bar

Output signal

2-wire: 4 ... 20 mA
3-wire: 0 ... 20 mA / 0 ... 10 V
others on request

Product characteristics

- ▶ pressure port PVDF-version for aggressive media
- ▶ pressure port G 1 1/2" for pasty and polluted media



Optional versions

- ▶ IS-version
Ex ia = intrinsically safe for gases and dusts
- ▶ diaphragm 99.9 % Al₂O₃
- ▶ customer specific versions



The screw-in transmitter ILMK 351 has been designed for measuring small system pressure and level measurement in container. The ILMK 351 is based on an own-developed capacitive ceramic sensor element. Usage in viscous and pasty media is possible because of the flush mounted sensor.

For the usage in aggressive media a pressure port in PVDF and the diaphragm in Al₂O₃ 99.9 % is available. An intrinsically safe version complete the range of possibilities.

Preferred areas of use are

-  Plant and Machine Engineering
-  Environmental Engineering (water – sewage – recycling)

Preferred used for

-  Fuel and Oil
-  Viscous and Pasty Media



Pressure ranges																
Nominal pressure	[bar]	0.04	0.06	0.1	0.16	0.25	0.4	0.6	1	1.6	2.5	4	6	10	16	20
Level	[mH ₂ O]	0.4	0.6	1	1.6	2.5	4	6	10	16	25	40	60	100	160	200
Overpressure	[bar]	2	2	4	4	6	6	8	8	15	25	25	35	35	45	45
Low pressure	[bar]	-0.2		-0.3		-0.5			-1							

Output signal / Supply	
Standard	2-wire: 4 ... 20 mA / V _S = 9 ... 32 V _{DC}
Option Ex-version	2-wire: 4 ... 20 mA / V _S = 14 ... 28 V _{DC}
Option 3-wire	3-wire: 0 ... 10 V / V _S = 12.5 ... 32 V _{DC}

Performance	
Accuracy ¹	standard: ≤ ± 0.35 % FSO option: ≤ ± 0.25 % FSO
Permissible load	current 2-wire: R _{max} = [(V _S - V _{S min}) / 0.02 A] Ω voltage 3-wire: R _{min} = 10 kΩ
Influence effects	supply: 0.05 % FSO / 10 V load: 0.05 % FSO / kΩ
Long term stability	≤ ± 0.1 % FSO / year at reference conditions
Turn-on time	700 msec
Mean measuring time	5/sec
Response time	mean response time: ≤ 200 msec max. response time: 380 msec

¹ accuracy according to IEC 60770 - limit point adjustment (non-linearity, hysteresis, repeatability)

Thermal effects (Offset and Span) / -Permissible temperatures			
Tolerance band	≤ ± 0.1 % FSO / 10 K	in compensated range - 20 ... 80 °C	
Permissible temperatures ²	medium: -40 ... 125 °C	electronics / environment: -40 ... 85 °C	storage: -40 ... 100 °C

² for pressure port of PVDF the minimum permissible temperature is -30 °C

Electrical protection	
Short-circuit protection	permanent
Reverse polarity protection	no damage, but also no function
Electromagnetic compatibility	emission and immunity according to EN 61326

Mechanical stability	
Vibration	10 g RMS (20 ... 2000 Hz) according to DIN EN 60068-2-6
Shock	100 g / 1 msec according to DIN EN 60068-2-27

Materials (media wetted)			
Pressure port	standard: stainless steel 1.4404 (316L)	option: PVDF	
Housing	standard: stainless steel 1.4404 (316L)	option: PVDF	
Seals	FKM -40 ... 125 °C FFKM -15 ... 125 °C EPDM -40 ... 125 °C		
Diaphragm	standard: ceramics Al ₂ O ₃ 96 % options: ceramics Al ₂ O ₃ 99.9 %		
Media wetted parts	pressure port, seals, diaphragm		

IS-protection (only for 4 ... 20 mA / 2-wire)	
Approval DX14-LMK 351	IBExU05ATEX1070 X stainless steel-pressure port with male (connector): zone 0: II 1 G Ex ia IIC T4 Ga zone 20: II 1D Ex iaD 20 T85°C stainless steel-pressure port with cable: zone 0: II 1 G Ex ia IIB T4 Ga zone 20: II 1D Ex iaD 20 T85°C plastic-pressure port with male (connector): zone 0/1 ³ : II 1/2 G Ex ia IIC T4 Ga/Gb zone 20/21 ⁴ : II 1D Ex iaD 20 T85°C plastic-pressure port with cable: zone 0/1 ³ : II 1/2 G Ex ia IIB T4 Ga/Gb zone 20/21 ⁴ : II 1D Ex iaD 20 T85°C
Safety technical maximum values	U _i = 28 V, I _i = 93 mA, P _i = 660 mW, C _i = 27 nF, L _i = 5 μH
Max. permissible temperature for environment	in zone 0: -20 ... 60 °C for p _{atm} 0.8 bar up to 1.1 bar zone 1 and higher: -25 ... 70 °C
Connecting cables (by factory)	capacity: signal line / shield also signal line / signal line: 160 pF/m inductance: signal line / shield also signal line / signal line: 1 μH/m

³ The designation depends on the used pressure range. With nominal pressure ranges ≤ 60 mbar the designation is „2G“.
⁴ With nominal pressure ranges > 60 mbar and < 10 bar (see item 17 of the type-examination certificate) must be attended!

Miscellaneous	
Current consumption	signal output current: max. 21 mA signal output voltage: max. 5 mA
Weight	approx. 200 g
Installation position	any
Operational life	> 100 x 10 ⁶ loading cycles
CE-conformity	EMV-directive: 2004/108/EC
ATEX Directive	94/9/EC

Wiring diagram

2-wire-system (current)

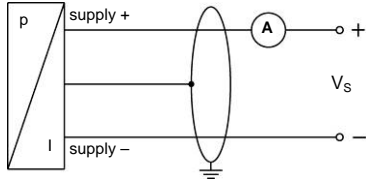

3-wire-system (current/voltage)

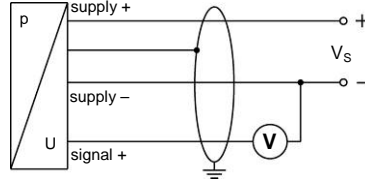

Pin configuration

Electrical connection	ISO 4400	Binder 723 (5-pin)	M12x1 (4-pin)	field housing	cable colours (DIN 47100)
Supply +	1	3	1	IN +	wh (white)
Supply -	2	4	2	IN -	bn (brown)
Signal + (only for 3-wire)	3	1	3	OUT +	gn (green)
Shield	ground pin	5	4	⊥	gn/ye (green/yellow)

Electrical connections (dimensions in mm)

standard

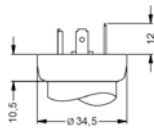

ISO 4400 (IP 65)

option

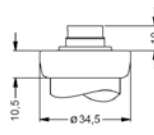

Binder Series 723 5-pin (IP 67)

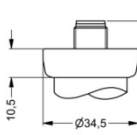

M12x1 4-pin (IP 67)

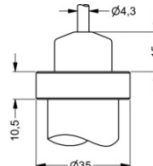

cable outlet with PVC cable (IP 67)⁴

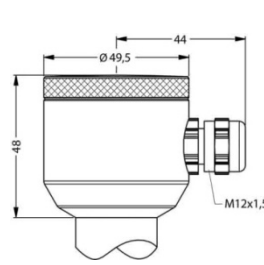

compact field housing (IP 67)

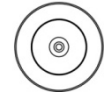
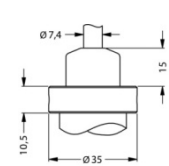

cable outlet, cable with ventilation tube (IP 68)⁵

⁴ standard: 2 m PVC cable without ventilation tube (permissible temperature: -5 ... 70 °C)
⁵ different cable types and lengths available, permissible temperature depends on kind of cable

Dimensions (in mm)

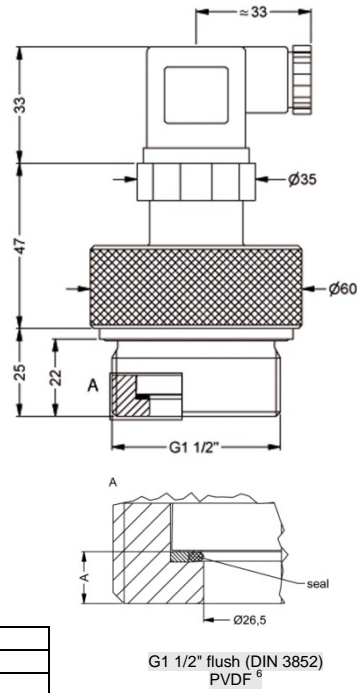
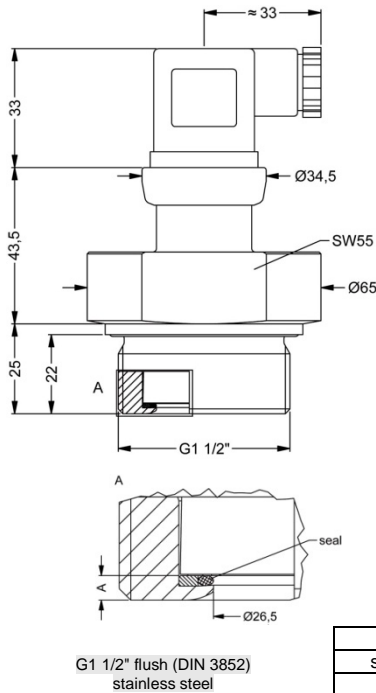

⁶ not possible in combination with compact field housing

This data sheet contains product specification, properties are not guaranteed. Subject to change without notice.

Ordering code ILMK 351

ILMK 351

--	--	--	--	--	--	--	--	--	--	--	--	--	--	--	--	--	--	--	--

Pressure																				
	in bar		4	7	0															
	in mH ₂ O		4	7	1															
Input	[mH₂O]	[bar]																		
	0.4	0.04		0	4	0	0													
	0.6	0.06		0	6	0	0													
	1.0	0.10		1	0	0	0													
	1.6	0.16		1	6	0	0													
	2.5	0.25		2	5	0	0													
	4.0	0.40		4	0	0	0													
	6.0	0.60		6	0	0	0													
	10	1.0		1	0	0	1													
	16	1.6		1	6	0	1													
	25	2.5		2	5	0	1													
	40	4.0		4	0	0	1													
	60	6.0		6	0	0	1													
	100	10		1	0	0	2													
	160	16		1	6	0	2													
	200	20		2	0	0	2													
	customer			9	9	9	9													consult
Output																				
	4 ... 20 mA / 2-wire							1												
	0 ... 10 V / 3-wire							3												
	Intrinsic safety 4 ... 20 mA / 2-wire							E												
	customer							9												consult
Accuracy																				
standard	0.35 %							3												
option	0.25 %							2												
	customer							9												consult
Electrical connection																				
	Male and female plug ISO 4400							1	0	0										
	Male plug Binder series 723 (5-pin)							2	0	0										
	Cable outlet with PVC- cable ¹							T	A	0										
	Cable outlet ²							T	R	0										
	Male plug M12x1 (4-pin) / metal							M	1	0										
	compact field housing							8	5	0										
	customer							9	9	9										consult
Mechanical connection																				
	G1 1/2" DIN 3852 with flush sensor							M	0	0										
	customer							9	9	9										consult
Seals																				
	FKM										1									
	EPDM										3									
	FFKM										7									
	customer										9									consult
Pressure port																				
	Stainless steel 1.4404 (316L)										1									
	PVDF ³										B									
	customer										9									consult
Diaphragm																				
	Ceramics Al ₂ O ₃ 96%										2									
	Ceramics Al ₂ O ₃ 99.9%										C									
	customer										9									consult
Special version																				
	standard										0	0	0							
	customer										9	9	9							consult

¹ standard: 2 m PVC cable without ventilation tube (permissible temperature: -5 ... 70 °C)
² cable with ventilation tube (code TR0 = PVC cable), different cable types and lengths available, price without cable
³ not possible in combination with compact field housing; min. permissible temperature -30 °C

This document contains product specification; properties are not guaranteed. Detailed information about options are defined in the datasheet. Subject to change without notice.