



ix | act i

Precision Pressure Transmitter for Food Industry, Pharmacy and Biotechnology

Stainless Steel Sensor

accuracy according to IEC 60770:
0.1 % FSO

Nominal pressure

from 0 ... 400 mbar up to 0 ... 40 bar

Output signals

2-wire: 4 ... 20 mA
others on request

Special characteristics

- ▶ turn-down 1:10
- ▶ hygienic version
- ▶ flush welded diaphragm
- ▶ several process connections (G1" cone, Clamp, dairy pipe, etc.)
- ▶ integrated display and operating module

Optional versions

- ▶ IS-version
Ex ia = intrinsically safe for gases and dusts
- ▶ HART®-communication
- ▶ cooling element for media temperatures up to 300 °C

The precise pressure transmitter x|act i has been especially designed for the food industry, pharmacy and biotechnology and measures vacuum, gauge and absolute pressure of gases, steam and fluids up to 40 bar.

Several process connections e.g. thread or hygienic versions like Varivent®, dairy pipe and Clamp with a flush welded diaphragm are available, which can be combined with a cooling element for media temperatures up to 300 °C. The robust stainless steel globe housing has a high ingress protection IP 67 and all characteristics for a residue-free and antibacterial cleaning.

Preferred areas of use are



Food Industry



Pharmacy

Material and test certificates

- ▶ material mill test report according to DIN EN 10204-3.1.
- ▶ specific test report according to DIN EN 10204-2.2



Pressure ranges ¹								
Nominal pressure gauge / abs.	[bar]	0.4	1	2	4	10	20	40
Overpressure	[bar]	2	5	10	20	40	80	105
Burst pressure	[bar]	3	7,5	15	25	50	120	210

¹ higher pressure ranges on request; on demand we adjust the devices within the turn-down-possibility by software on the required pressure ranges
² absolute pressure possible from 1 bar

Vacuum ranges						
Nominal pressure gauge	[bar]	-0.4 ... 0.4	-1 ... 1	-1 ... 2	-1 ... 4	-1 ... 10
Overpressure	[bar]	2	5	10	20	40
Burst pressure	[bar]	3	7,5	15	25	50

Output signal / Supply	
Standard	2-wire: 4 ... 20 mA / V _S = 12 ... 30 V _{DC}
Option	IS-protection: 2-wire: 4 ... 20 mA / V _S = 12 ... 28 V _{DC} IS-protection / HART®: 2-wire: 4 ... 20 mA with HART® communication / V _S = 12 ... 28 V _{DC}
Current consumption	max. 25 mA

Performance		
Accuracy ³	≤ ± 0.1 % FSO	The accuracy is calculated as follows ≤ 0.1 + 0.015 x (turn-down - 5) % FSO e.g. turn-down 9: ≤ 0.1 + 0.015 x (9 - 5) % FSO = 0.16 % FSO
Performance after turn-down	- turn-down ≤ 1:5: no change - turn-down > 1:5:	
Permissible load	R _{max} = [(V _S - V _{S min}) / 0.02 A] Ω	load during HART® communication: R _{min} = 250 Ω
Influence effects	supply: 0.05 % FSO / 10 V	permissible load: 0.05 % FSO / kΩ
Long term stability	≤ ± (0.1 x turn-down) % FSO / year at reference conditions	
Response time	100 msec – without consideration of electronic damping	measuring rate 10/sec
Adjustability	electronic damping: 0 ... 100 sec offset: 0 ... 90 % FSO	turn-down of span: max. 1:10

³ accuracy according to IEC 60770 – limit point adjustment (non-linearity, hysteresis, repeatability)

Thermal effects (Offset and Span) / Permissible temperatures	
Tolerance band ^{4,5}	≤ ± 0.2 % FSO x Turn-Down
in compensated range	-20 ... 85 °C
Permissible temperatures ⁶	medium: -40 ... 125 °C for filling fluid silicon oil -10 ... 125 °C for filling fluid food compatible oil environment: -20 ... 70 °C storage: -30 ... 80 °C
Permissible temperature medium for cooling element 300°C	filling fluid silicon oil overpressure: -40 ... 300 °C vacuum pressure: -40 ... 150 °C filling fluid food compatible oil overpressure: -10 ... 250 °C vacuum pressure: -10 ... 150 °C

⁴ an optional cooling element can influence thermal effects for offset and span depending on installation position and filling conditions

⁵ for flange-, Varivent-, DRD-version: tolerance band offset ≤ ± 1.6 % FSO / tolerance band span ≤ ± 0.6 % FSO

⁶ for vacuum ranges and absolute pressure the max. medium temperature is 70 °C; max. temperature of the medium for nominal pressure gauge > 0 bar: 150 °C for 60 minutes with a max. environmental temperature of 50 °C (without cooling element).

Electrical protection	
Short-circuit protection	permanent
Reverse polarity protection	no damage, but also no function
Electromagnetic compatibility	emission and immunity according to EN 61326

Mechanical stability	
Vibration	5 g RMS (25 ... 2000 Hz) according to DIN EN 60068-2-6
Shock	100 g / 11 msec according to DIN EN 60068-2-27

Filling fluids	
Standard	silicon oil
Options	food compatible oil (with FDA approval) (Mobil SHC Cibus 32; Category Code: H1; NSF Registration No.: 141500) Halocarbon and others on request

Materials	
Pressure port	G1" cone, Varivent®, dairy pipe und clamp: stainless steel 1.4435 (316 L) DRD and flange: stainless steel 1.4404 (316L)
Housing	stainless steel 1.4301 (304)
Viewing glass	laminated safety glass
Seals (media wetted)	none, not included in the scope of delivery
Diaphragm	Standard: stainless steel 1.4435 (316 L) options: Hastelloy® C-276 (2.4819); Tantal (possible from 1 bar on) on request
Media wetted parts	pressure port, diaphragm, seals (if existing)

Explosion protection	
Approval AX12-x act i	IBExU 05 ATEX 1106 X zone 0: II 1G Ex ia IIC T4 Ga / II 1D Ex ia IIIC T85 °C Da
Safety technical maximum values	$U_i = 28 \text{ V}$, $I_i = 93 \text{ mA}$, $P_i = 660 \text{ mW}$, $C_i = 0 \text{ nF}$, $L_i = 0 \text{ }\mu\text{H}$, the supply connections have an inner capacity of max. 27 nF to the housing
Permissible temperatures for environment	in zone 0: -20 ... 60 °C with p_{atm} 0.8 bar up to 1.1 bar in zone 1: -25 ... 70 °C
Connecting cables (by factory)	capacitance: signal line/shield also signal line/signal line: 160 pF/m inductance: signal line/shield also signal line/signal line: 1 $\mu\text{H}/\text{m}$
Miscellaneous	
Display	LC display, visible range 32.5 x 22.5 mm; 5-digit 7-segment main display, digit height 8 mm, range of indication ± 9999 ; 8-digit 14-segment additional display, digit height 5 mm; 52-segement bargraph; accuracy 0.1% \pm 1 digit
Ingress protection	IP 67
Installation position	any (standard calibration in a vertical position with the pressure port connection down; differing installation position for $P_N \leq 2 \text{ bar}$ have to be specified in the order)
Weight	min. 400 g (depending on mechanical connection)
Operational life	> 100 x 10 ⁶ pressure cycles
CE-conformity	EMC Directive: 2004/108/EC

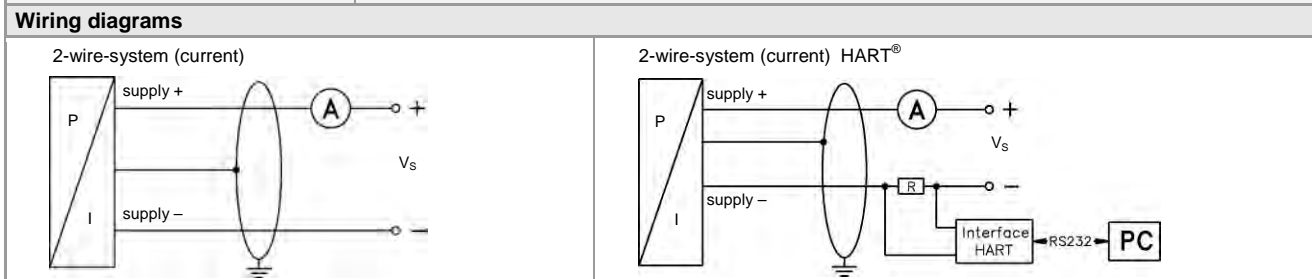

Pin configuration

Electrical connections	M12x1 (4-pin)	cable colours (DIN 47100)
Supply +	1	wh (white)
Supply -	3	bn (brown)
Shield	plug housing	ye/gn (yellow / green)

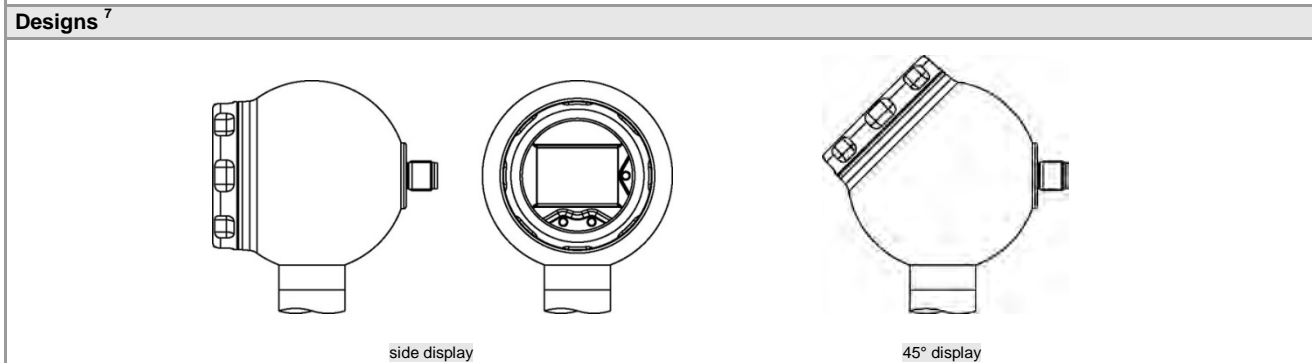
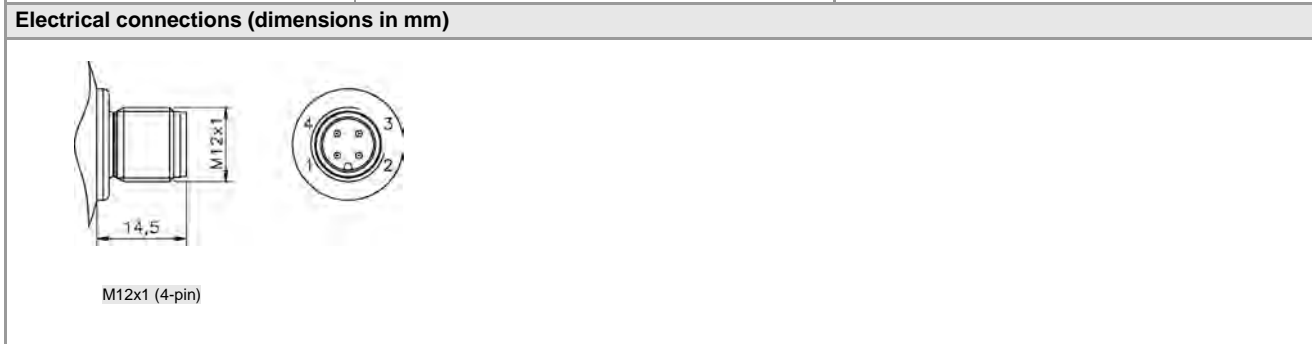

⁷ all designs in combination with G1" cone in horizontal rotatable housing as standard; other mech. connections in rotatable housing on request

Dimensions (in mm)

G1" cone

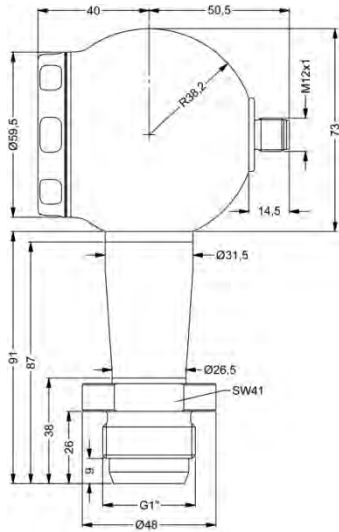

Clamp (ISO 2852)

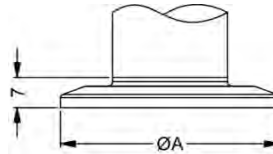

dimensions in mm			
size	1"	1 1/2"	2"
A	50.5	50.5	64
P _N [bar]	≤ 16	≤ 16	≤ 16

Dairy pipe ⁷ (DIN 11851)

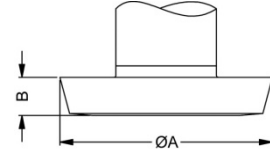

dimensions in mm			
size	DN 25	DN 40	DN 50
A	44	56	68.5
B	10	10	11
P _N [bar]	≤ 40	≤ 40	≤ 40

Varivent[®]

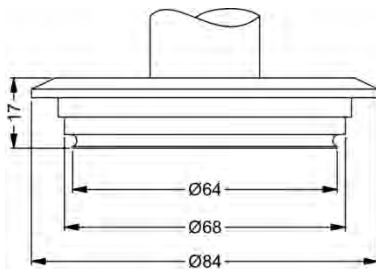

DN 40/50
PN ≤ 25 bar

Flange (DIN 2501)

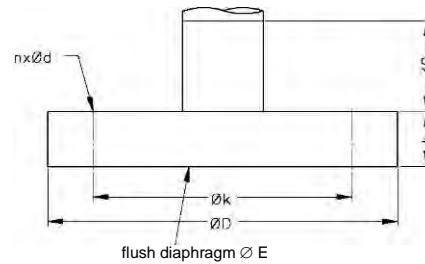

dimensions in mm			
size	DN25	DN50	DN80
D	115	165	200
E	30	89	89
k	85	125	160
b	18	20	20
n	4	4	8
d	14	18	18
PN	≤ 40 bar	≤ 40 bar	≤ 16 bar

DRD ⁸

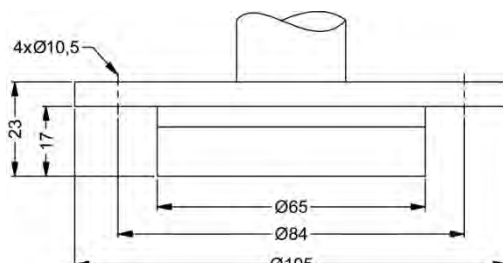

PN ≤ 25 bar

Cooling element

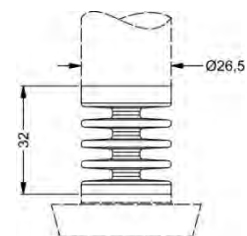

temperature range 300 °C

⁸ cup nut resp. mounting flange is included in the delivery (already pre-assembled)
HART[®] is a registered trade mark of HART Communication Foundation; Hastelloy[®] is a trademark of Haynes International Inc.;
Varivent[®] is a trademark of GEA Tuchenhagen GmbH; Windows[®] is a registered trade mark of Microsoft Corporation

