

Element	Function
1	Infrared lens IR measurement
2	4-point laser Measuring spot marking
3	Humidity probe (only H1) Measures the relative humidity
4	<b>Trigger</b> - Switches the instrument on. - Starts / ends a measurement.
5	Battery compartment Contains 3x AA batteries.
6	USB interface / probe connection socket - For connecting the instrument to the PC to connect to the EasyClimate software. - Connection of a probe.
7	Joystick for confirming a selection. - For navigating in the menu
8	<b>ESC</b> Takes the user a step back in the menu selection.
9	Switches the testo 835 on or off.
10	Saves the measured readings.
11	Setting emissivity
12	<b>HOLD / SCAN</b> - Scan: while the trigger is held down and the measurement is carried out. - Hold: displays the measured values.
13	Time Displays the current time.
14	Reading display Displays the measured readings. <b>Surface temperature (IR)</b> Max. IR temperature IR temperature Min. IR temperature
	<b>Differential (surface temperature - external probe temperature)</b> TC temperature IR temperature Temperature difference TC / IR measurement TC probe must be connected.
	<b>Humidity measurement (environment + dewpoint + IR) (only H1)</b> Ambient humidity IR temperature Ambient dewpoint temperature

Element	Function
[%RH] [°C/°F] [°Ctd/°Ftd]	<b>Humidity measurement (environment and dewpoint) – ambient temperature (only H1)</b> Ambient humidity Ambient temperature Ambient dewpoint temperature.
<b>Max</b> [°Ctd/°Ftd] <b>Min</b>	<b>Dewpoint distance measurement (only H1)</b> Temperature difference IR minus dewpoint max current min.
<b>Max</b> <b>aw[-]</b> <b>Min</b>	<b>Surface moisture measurement (only H1)</b> Surface moisture max. current min. Calculated from dewpoint, ambient air and surface temperature - 0.00 - 0.64: non-critical - 0.65 - 0.80: poss. critical - 0.81 - 1.00: critical
15	Displays the battery charge status.
16	Displayed if alarm is switched on.
17	Displays the selected emissivity.
18	Displayed if laser is switched on.

#### Connecting the thermocouple probe

- 1 - Connect the connecting plug to the probe socket (6).

#### Switching the instrument on

- 1 - Press (9).  
- OR  
- Press **Trigger** (4).

#### Switching the instrument off



- 1 - Hold down (9) until the display goes off.

If no button is pressed for 2 minutes, the instrument switches off automatically.

### Carrying out the measurement

- 1 - Hold down **Trigger** (4).
- 2 - Release **Trigger** (4) to end the measurement.
- 3 - Move  (7) up / down to change the reading display.

### Making settings

- 1 - Press  (7) to open the menu.
- 2 - Move and press  (7) to select the menu item.
- 3 - Moving and pressing  (7) applies the settings.

### Setting the emissivity



 Materials have various emissivities, i.e. they emit various amounts of electromagnetic radiation. The emissivity of the instrument has a default setting of 0.95. This is ideal for the measurement of non-metals (paper, ceramic, gypsum, wood, paints and varnishes), plastics and foodstuffs.

- 1 - Press **ε** (11).
- 2 - For **Customise manual** and **Customise auto**, move  (7) right to enter the emissivity.

 For **Customise auto**, please refer to the instruction manual.

- 3 - Press  (7) to confirm the selected emissivity.

### Creating a storage location and saving readings

- 1 - Press  (10) to open the memory function.
- 2 - Select **New Location**.
- 3 - Move  (7) up / down or right / left to name the storage location.
- 4 - Confirm storage with .

### Measuring lens

(Ratio of distance: measuring range)

Depending on the distance of the measuring instrument from the measurement object, a specific measuring range is recorded.

*In italics = laser*

Not in italics = measuring range

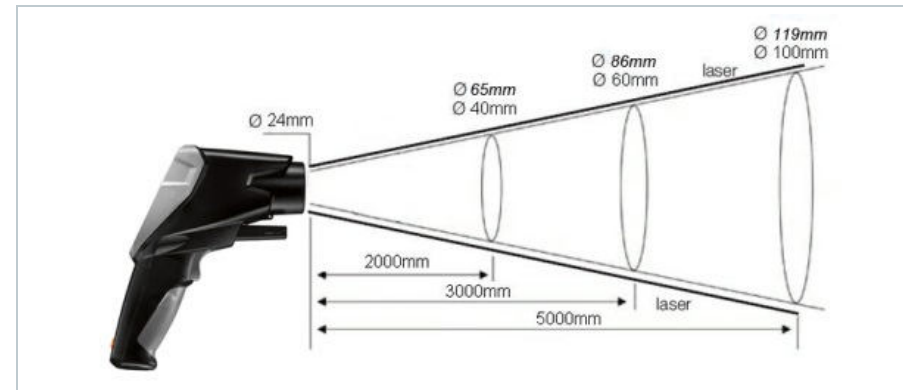

### Managing the measurement data and other measurement options

Please download the free testo EasyClimate software for managing and archiving your measurement data and for carrying out an online measurement.

You will find the link to download it here: [www.testo.com/download-center](http://www.testo.com/download-center)

# testo 835-H1 short instruction

[www.testo.com](http://www.testo.com)



 These brief instructions describe the basic operating steps. Please refer to the instruction manual to find out how to handle the product safely and for detailed information.