

Resistance thermometer TR10-L, TR10-0, TR10-2
Thermocouples TC10-L, TC10-0, TC10-2
Type of explosion protection - "flameproof enclosure" (Ex d)

Ex



Examples: TR10-L, TC10-L,

**TR10-0, TC10-0,
TR10-2, TC10-2**

© 06/2021 WIKA Alexander Wiegand SE & Co. KG
All rights reserved.
WIKA® is a registered trademark in many countries.

Read these operating instructions before carrying out any work!
Keep them for future reference!
This document is intended for use only in the EEU countries.

Content

1. General information	4
2. Safety	5
3. Specifications	9
4. Design and function	12
5. Transport, packaging, preservation, storage	13
6. Commissioning, operation	14
7. Information on installation and operation in hazardous areas	16
8. Safety instructions	17
9. Maintenance and cleaning	20
10. Faults	21
11. Dismounting, return and disposal	22

Declarations of conformity can be found at www.wika.com

1. General information

1. General information

- The instrument described in these operating instructions is manufactured using the latest technology. All components are carefully monitored for quality and compliance with environmental protection requirements. Our quality control systems are certified to ISO 9001 and ISO 14001.
- These operating instructions contain important information on operating the instrument. For safe operation, all safety instructions and operating instructions must be observed.
- Observe the applicable local safety standards and regulations, as well as the general safety regulations applicable to the specific application area of the instrument.
- These operating instructions are included in the scope of delivery of the product and must be kept in the immediate vicinity of the measuring instrument in a place that is fully accessible to the relevant specialists.
- Before using the instrument, skilled personnel must have carefully read and understood these operating instructions.
- The manufacturer disclaims any liability in case of damage caused by using the instrument contrary to its intended use, non-compliance with these operating instructions, operating the instruments by insufficiently qualified skilled personnel or making unauthorised modifications to the design.
- It is necessary to comply with the conditions specified in the supplier's documentation for the instrument.
- The company reserves the right to make technical changes to the design.
- Additional Information:
 -

Explanation of symbols



CAUTION!

... indicates a potentially dangerous situation that can result in serious injury or death to personnel, if not avoided.



WARNING!

... indicates a potentially hazardous situation that can result in minor injury, damage to equipment or environmental damage, if ignored..



Information

... is used to indicate helpful tips, recommendations, and information to ensure efficient, trouble-free operation.

1. General information / 2. Safety



CAUTION!

... indicates a potentially dangerous situation in the hazardous area that can result in serious injury or death to personnel, if not avoided.



CAUTION!

... indicates a potentially dangerous situation that can result in burns from contact with hot surfaces or liquids, if ignored.

EN

2. Safety



CAUTION!

Before installing, commissioning and operating the instrument, make sure that the thermometer has been properly selected with regard to the measuring range, its design and the special measuring conditions.

The thermowell must be selected according to the maximum pressures and temperatures (specified, for example in the data sheet according to DIN 43772).



Failure to do so may result in serious injury and/or damage to equipment.

For more detailed and important safety instructions, see the corresponding sections of these operating instructions.

2.1 Intended use

These instruments are used to measure temperature in hazardous areas of industrial applications.

The instrument has been designed and manufactured exclusively for the applications described in these operating instructions and must only be used for this purpose.

You must familiarise yourself with specifications in these operating instructions. Incorrect handling or operation outside the permissible limits requires the instrument to be switched off immediately and inspected by a certified WIKA service engineer.

Condensation can form when moving the instrument from a cold to a warm environment; this can lead to malfunction. Before putting the instrument into operation, wait until it has warmed up to the temperature of the room in which it is operated.

The manufacturer's liability is void if the instrument is used contrary to its intended use.

2.2 Personnel qualification



CAUTION!

Risk of injury due to insufficiently qualified personnel!

Improper handling of the instrument can result in serious injury or damage to equipment.

- The activities described in these operating instructions may only be carried out by skilled personnel who have the qualifications described below.
- Do not allow unskilled personnel to enter the hazardous area.

Skilled personnel

Skilled personnel are understood to be personnel who, based on their technical training, knowledge of measurement and control technology and on their experience and knowledge of country-specific regulations, current standards and directives, are capable of carrying out the actions described and independently recognising potential hazards.

Special operating conditions require special knowledge, for example about aggressive media.

List of possible personnel (user) errors leading to equipment malfunctions and actions to prevent these errors

Personnel errors are:

1. Incorrect electrical connection. To ensure proper connection, follow the instructions in the "Electrical connections" section.
2. Failure to perform test and incoming inspection of instruments before commissioning.
3. Any actions that can cause the temperature of the instrument surfaces to rise above the values allowed for a particular temperature class. The instrument must be installed in such a way that an increase in the ambient temperature would never cause the temperature of the instrument surfaces to rise above the values allowed for the specific temperature class. The instrument must not be installed in direct sunlight or near heating equipment.
4. Connection to the devices of the uncertified secondary equipment and/or exceeding the permitted parameters of electrical circuits. When connecting, observe the requirements of the instructions for connecting and operation of the secondary equipment.

2.3 Special hazards



CAUTION!

Read the information in the corresponding certificate and the regulations for installation in hazardous areas (e.g. GOST IEC 60079-14). Failure to do so may result in serious injury and/or damage to equipment.

Additional safety instructions for instruments intended for use in hazardous areas can be found in section 7 "Information on installation and operation in hazardous areas".



CAUTION!

For hazardous media such as oxygen, acetylene, flammable or poisonous gases and liquids, as well as for refrigerators, compressors, etc., the requirements of the relevant rules and regulations must additionally be met.



CAUTION!

When working with open circuits (printed circuit boards), protection against electrostatic discharge is required. The work table must be grounded and personal wristbands must be provided to protect electrically sensitive electronic components.

To ensure the safe operation of the instrument, the operator must ensure that:

- the adequate first-aid equipment is available and medical care can be provided at any time required
- the operating personnel working with the instrument are instructed at regular intervals in all aspects concerning safety, providing first aid in case of an accident and environmental protection, and are familiar with the operating instructions, especially with the safety instructions contained in this document.



CAUTION!

Residual media in dismantled instruments can pose a risk to personnel, the environment and the equipment.

Take sufficient precautionary measures.

Do not use this instrument in emergency protection or emergency stop devices. Improper use of the instrument can result in personal injury.

If a fault occurs, the instrument may contain aggressive medium which can be extremely hot and under pressure or vacuum.

2. Safety

2.4 Labelling, safety marks

Product label (example)

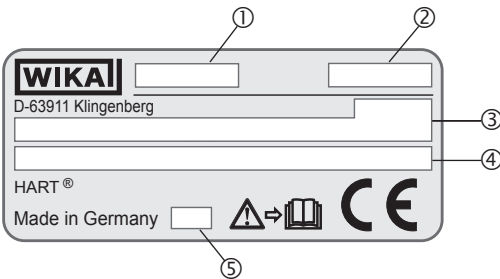

■ Product plate for measuring insert Tx10-K

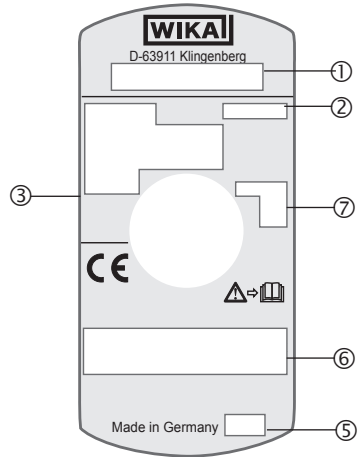

■ Additional information for instruments with explosion protection certificates

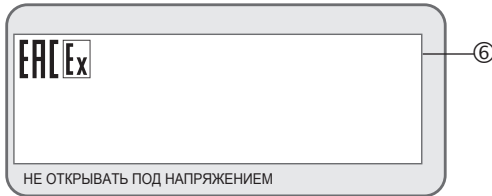

- ① Model
- ② Serial number
- ③ Information on the version (measuring element, measuring range...)



Sensor element according to the standard (resistance thermometer)

- F = Thin-film measuring resistor
- W = Wire-wound measuring resistor

Sensor element according to the standard (thermocouple)

- ungrounded
- grounded

- ③ Transmitter model (only for version with transmitter)
- ⑤ Year of manufacture
- ⑥ Certification details, certificate number, explosion protection marking
- ⑦ Sensor symbol

- ungrounded  = ungrounded, welded
- grounded  = welded to the sheath (grounded)
- quasi grounded  = The thermometer is, due to its low isolation clearances between sensor and sheath, to be considered as grounded.



Before mounting and commissioning the instrument, ensure you read the operating instructions!

3. Specifications

3.1 Resistance thermometer

Sensor connection method

- 2-wire
- 3-wire
- 4-wire

Sensor tolerance value per IEC 60751

- Class B
- Class A
- Class AA

The combinations of a 2-wire connection with class A or class AA are not permissible, since the lead resistance of the measuring insert negates the higher sensor accuracy.

Basic values and tolerance values

Basic values and tolerance values for the platinum measurement resistances are laid down in IEC 60751.

The nominal value of Pt100 sensors is 100 Ω at 0 °C. The temperature coefficient α can be stated simply to be between 0 °C and 100 °C with:

$$\alpha = 3.85 \cdot 10^{-3} \text{ }^{\circ}\text{C}^{-1}$$

The relationship between temperature and electrical resistance is described by polynomials, which are also defined in IEC 60751. Moreover, this standard specifies the basic values in °C steps in tabular form.

Class	Temperature range		Accuracy in °C
	Wire-wound (W)	Thin-film (F)	
B	-196 ... +600 °C	-50 ... +500 °C	$\pm(0,30 + 0,0050 t)$ ¹⁾
A	-100 ... +450 °C	-30 ... +300 °C	$\pm(0,15 + 0,0020 t)$ ¹⁾
AA	-50 ... +250 °C	0 ... +150 °C	$\pm(0,10 + 0,0017 t)$ ¹⁾

1) |t| is the value of the temperature in °C without consideration of the sign.

For further specifications see WIKA data sheet and the technical information sheet IN 00.17 "Usage limitations and accuracies of platinum resistance thermometers per IEC 60751".

3. Specifications

3.2 Thermocouples

3.2.1 Sensor types

Type	Recommended max. operating temperature		
	IEC 60584-1:2013		ASTM E230
	Class 1	Class 2	Standard, special
K	1,000 °C (1,832 °F)	1,200 °C (2,192 °F)	1,260 °C (2,300 °F)
J	750 °C (1,382 °F)	750 °C (1,382 °F)	760 °C (1,400 °F)
E	800 °C (1,472 °F)	900 °C (1,652 °F)	870 °C (1,598 °F)
N	1,000 °C (1,832 °F)	1,200 °C (2,192 °F)	1,260 °C (2,300 °F)
T	350 °C (662 °F)	350 °C (662 °F)	370 °C (698 °F)

3.2.2 Potential measurement uncertainties

Important factors which counteract the long-term stability of thermocouples.

Ageing effects/poisoning

- Oxidation processes in thermocouples that are not properly protected (“bare” thermocouple conductors) lead to changes in the characteristic curve.
- Foreign atoms (poisoning) that diffuse into the alloy lead to changes in the initial composition of the alloy and therefore lead to a change in the characteristic curve.
- The influence of hydrogen makes the thermocouples brittle.

The nickel conductor of a type K thermocouple is often subject to damage by sulphur contained, for example in exhaust gases.

Type J and T thermocouples are less subject to ageing, as conductors made of unadulterated metal oxidise faster. In any case, an increase in temperature accelerates the ageing effect.

Green rot

If the type K thermocouples are used at temperatures between approximately 800 °C and 1050 °C, this can lead to significant changes in thermoelectric voltage. This is caused by depletion or oxidation of the chromium in the NiCr conductor (positive terminal). A precondition is a low concentration of oxygen or vapour in the immediate environment of the thermocouple. The nickel conductor is not subjected to this. The consequence of this influence is a shift in the measured value caused by a decrease in thermoelectric voltage. This effect is exacerbated under oxygen starvation (rarefied atmosphere), as no protective layer of chromium oxide is formed on the surface of the thermocouple to protect the chromium itself.

Because of this effect, the thermocouple is permanently destroyed. The name “green rot” comes from the greenish, shimmering colouration at the break point of the conductor.

From this point of view, the type N thermocouple has an advantage due to silicon content. In this case, a protective oxide layer is formed under the same conditions.

3. Specifications

EN

K effect

The NiCr conductor of a type K thermocouple has an ordered crystal lattice structure at temperatures below 400 °C. If the thermocouple heats up more, this causes transition to a disordered state in the temperature range between about 400 °C and 600 °C. Above 600 °C, the state of the crystal lattice is restored. Abrupt cooling of such thermocouples (more than 100 °C per hour) leads to unwanted destruction of the ordered crystal lattice structure in the temperature range from approx. 600 °C to 400 °C. At the same time, the characteristic curve of a type K thermocouple assumes an ordered state which is described by numerical values. This results in a thermoelectric voltage error of up to 0.8 mV (about 5 °C) in the range. The K effect is reversible and in most cases can be eliminated by annealing at a temperature of over 700 °C followed by gradual cooling.

Thermocouples in an enclosure are particularly sensitive in this sense. Cooling in the open air can cause a deviation of up to 1 °C.

In type N thermocouples, it is possible to reduce the ordering effect of the structure within a narrow range by using silicon alloys.

The area of application of these thermometers is limited by both the maximum permissible temperature of the thermocouple and the maximum temperature of the thermocouple materials.

The models listed are available both as single and twin models. Unless specified otherwise, the thermocouple is supplied with an insulated measuring point.

Deviation

The cold junction temperature of 0 °C is used as the basis for calculating the deviation value. When using a compensating cable or thermocouple cable, an additional measuring deviation must be considered.

For deviation values and more detailed specifications, see the relevant WIKA data sheet and technical bulletin IN 00.23 "Use of thermocouples".



For detailed safety instructions on working in hazardous areas, see section 7 "Information on installation and operation in hazardous areas".

4. Design and function

4.1 Description

Resistance thermometers and thermocouples contain a measuring insert integrated in an Ex d certified connection. In combination with an explosion-proof fitting screwed into the head, the measuring insert acts as an explosion-proof connection. The measuring insert is replaceable.

Design of the sensor element of the resistance thermometer

The measuring resistor is located inside a housing made of ceramic, refractory compound or thermally conductive paste. The outer protection of the measuring insert tip is formed by a tube sealed on one side which is welded to the mineral-insulated cable.

Design of the sensor element of the thermocouple

The measuring insert of the thermocouple is manufactured from a mineral-insulated cable. The thermocouple consists of the internal conductors of such a cable. The junction point of the thermocouple, depending on the design, is either ungrounded, welded to the sheath of the mineral-insulated cable or welded and grounded.

If the temperature measuring element is intended for a grounded thermocouple, the thermocouple is directly connected to the enclosure. Designs with a diameter of less than 3 mm and grounded thermocouples are considered to be galvanically grounded.

Versions (see figures on page 19):

- Thermometers without explosion-proof fitting may only be used in combination with solid thermowells certified by WIKA with a minimum wall thickness of 1 mm. The thermometer is IIC marked and is suitable for use in zone 1.
- Once the explosion-proof fitting has been installed in the connection head of the thermometer, the thermowell does not need to be certified. Nevertheless, in most cases the use of a thermowell (solid or welded with a wall thickness of 1 mm) is necessary to ensure easy installation in the process. The thermometer is marked as IIB + H₂ and is suitable for use in zone 1.

The design of the thermowell can be anything, but the operating parameters of the process (temperature, pressure, density and flow rate) must be considered.

If a WIKA thermowell is already available or installed, an explosion-proof fitting is not required. WIKA thermometers are manufactured with certified Ex d connection heads. They are made of aluminium or stainless steel.

Permissible measuring ranges of the sensors:

Resistance thermometers TR10-L, TR10-0, TR10-2: -196 ... +600 °C

Thermocouples TC10-L, TC10-0, TC10-2: -40 ... +1,200 °C

4.2 Scope of delivery

Carefully check the delivery for completeness on the basis of the delivery note.

5. Transport, packaging, preservation, storage

5. Transport, packaging, preservation, storage

5.1 Transport

Packed products of the manufacturer may be transported by covered tracks and railroad cars as well as by airplanes in sealed compartments at ambient temperature from minus 50 to plus 60 °C, at relative humidity of no more than 80 %. During loading, unloading and transportation, the container with the products must not be exposed to shocks, falls and precipitation. The containers on the vehicle must be stacked in a way to exclude their movement during transportation. Check the instrument for any damage that may have been caused by transportation. Report any obvious damage to the supplier immediately.

5.2 Packaging

The products are packed according to the manufacturer's instructions. Each product is packed in an individual container – a cardboard box. Upon agreement with the customer, other types of packaging are allowed to ensure the safety of the product during transport and storage. The operating instructions are either enclosed in the product packaging or handed over directly to the user. There is no additional packaging for the documents. Do not remove the packaging until immediately before installation. Keep the package (e.g. for packing when changing installation location or sending the instrument for repair). Preservation is not carried out.

5.3 Storage

Permissible storage conditions:

- Storage temperature: -40 ... +80 °C
- Humidity: 35 ... 85 % relative humidity (without condensation)

Avoid exposure to the following factors:

- Direct sunlight or proximity to heated objects
- Mechanical vibration, mechanical shocks (falling on hard surfaces)
- Soot, fumes, dust and corrosive gases

Store in enclosed rooms. The designated storage period is 3 years. Re-inspection of the condition, replacement of individual components and parts with an expired shelf life must be carried out at least once every 3 months. Individual components and parts with an expired shelf life can only be replaced at the factory. Store the instruments in their original packaging in a location that complies with the above requirements. If the original packaging is not available, pack and store the equipment as follows:

1. Wrap the instrument in antistatic plastic film.
2. Place the instrument in a container with a shockproof material.
3. When storing for long periods (more than 30 days), place a desiccant bag in the packaging.



CAUTION!

Before storing the instrument (for later use), remove the media from the inside. This is of particular importance if the medium is hazardous to health, for example caustic, toxic, carcinogenic, radioactive, etc.

6. Commissioning, operation

6. Commissioning, operation

6.1 Removal and installation of the measuring insert

If maintenance is necessary, the explosion-proof fitting must be replaced together with the measuring insert. During recalibration, when removing the measuring insert, make sure that both surfaces of the explosion-proof connection (explosion-proof fitting and measuring insert) are not damaged.

6.2 Electrical connections

Connections to the terminal block

Thermoelectric transmitter

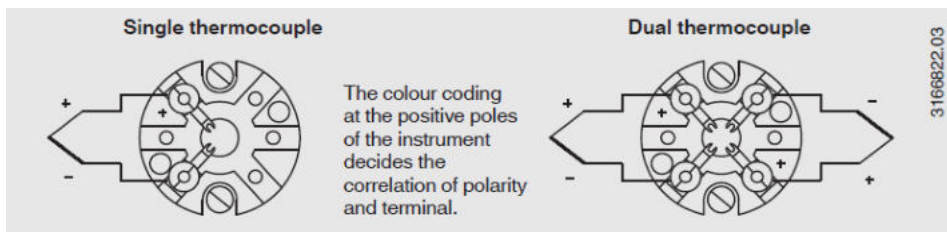

Resistance thermometers

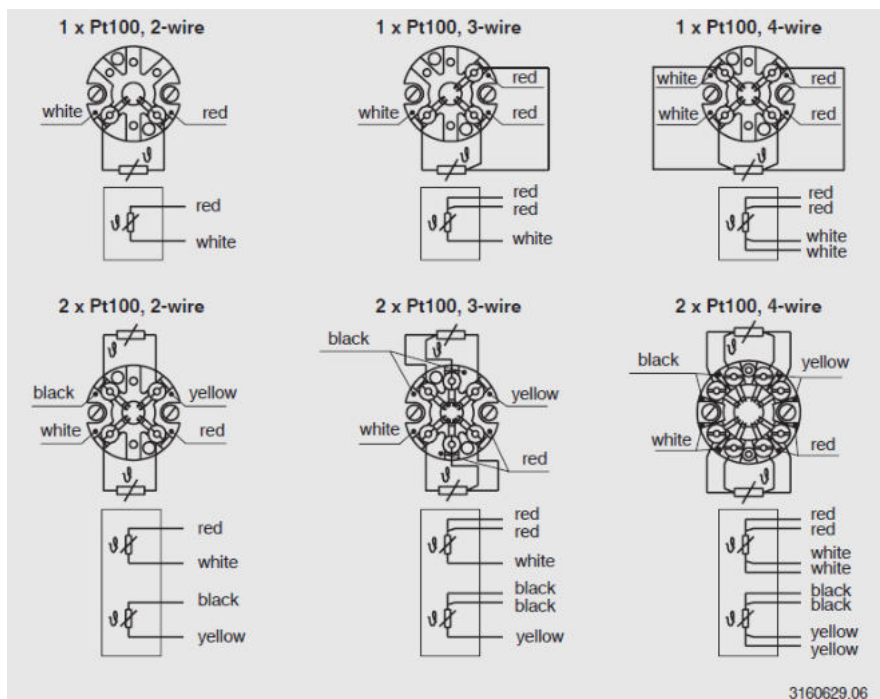

Connections to the transmitter built into the connection head (option)

For electrical characteristics (e.g. connection diagrams, measuring deviation values, etc.), see the corresponding operating instructions and/or data sheet for the transmitter built into the head.

6. Commissioning, operation

6.3 Tightening torques

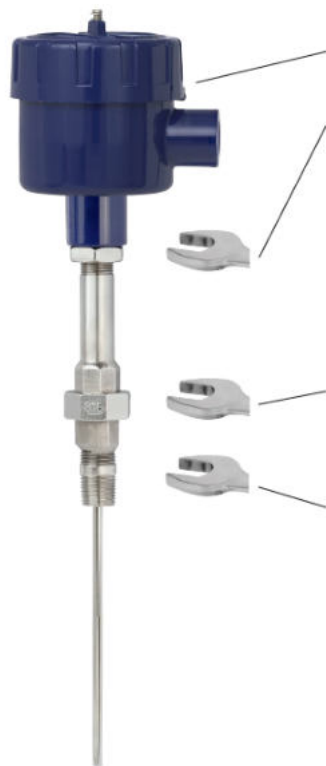

Connection head, selectable (example)

Tightening torques between connection head and neck tube

Thread	Tightening torques	
	Connection head material	
	Aluminium	Stainless steel
1/2 NPT	T.F.F.T 2 - 3 ¹⁾	T.F.F.T 2 - 3 ¹⁾
3/4 NPT	T.F.F.T 2 - 3 ¹⁾	T.F.F.T 2 - 3 ¹⁾
M20 x 1.5, with counter nut ²⁾	23 Nm	25 Nm
M24 x 1.5, with counter nut ²⁾	27 Nm	30 Nm

Tightening torques for connection to neck tube

Thread	Tightening torques
R 1	50 ... 60 Nm

Tightening torques for connection to thermowell

Thread	Tightening torques
1/2 NPT	T.F.F.T 2 - 3 ¹⁾
3/4 NPT	T.F.F.T 2 - 3 ¹⁾
G 1/2 B	35 Nm
G 3/4 B	40 Nm
M14 x 1.5	25 ... 30 Nm
M18 x 1.5	35 Nm
M20 x 1.5	35 ... 40 Nm
M27 x 2	40 ... 45 Nm

1) Turns from finger tight (T.F.F.T)

2) Only for versions with fabricated neck tube

- The instrument may only be screwed or unscrewed by means of the hexagon and only to the specified torque using a suitable tool.
- The required torque depends on the dimensions of the connection thread and the seal used (form/material).
- Screwing or unscrewing the connection head is not permitted..
- When screwing in the instrument, make sure that the thread is not bevelled.

6.4 Locking screw



Always tighten the locking screw to prevent the explosion-proof version of the head from being opened accidentally.

Before opening the head, always loosen the locking screw by the required value.

7. Information on installation and operation in hazardous areas

EN



CAUTION!

Ignoring the information contained in the operating instructions may compromise explosion protection.



The requirements of the ATEX directive must be complied with. In addition, the local regulations for use in hazardous areas (e.g. GOST IEC 60079-10-1-2013 and GOST IEC 60079-14) apply.

- It is the responsibility of the operator to classify hazardous areas, not of the manufacturer/supplier of the equipment.
- The operator guarantees and is responsible for ensuring that safety characteristics of all thermometers used are defined. Damaged thermometers must not be used.
- Only explosion-proof components (such as cables, cable entries, etc.) should be used for the installation of thermometers.
- The screen must be grounded in accordance with the requirements of GOST IEC 60079-14.
- If a transmitter/digital indicator (option) is used, read the following:
 - These operating instructions and the operating instructions of the transmitter/digital indicator
- Permitted explosion-proof electrical equipment connections for hazardous gas environments are specified in GOST IEC 60079-1-2013. Explosion-proof connections¹⁾ for cylindrical threads²⁾ must be ≥ 5 mm for enclosures of $< 100 \text{ cm}^3$ and ≥ 8 mm for enclosures of $> 100 \text{ cm}^3$. The number of turns used must be ≥ 5 . Explosion-proof connections¹⁾ for tapered threads²⁾ must have ≥ 5 turns in each part. The number of turns used must be ≥ 3.5 . These parameters for explosion-proof connections must be complied with during installation and operation.
- The direct threaded connection between the thermometer and the connection head must not be twisted or open. Any adjustment of the housing position must only be made using the additional “nipple-union nut-nipple” neck.
- The temperature resistance of the cable, depending on the temperature, must correspond to the permissible temperature of the enclosure. At ambient temperatures above $60 \text{ }^\circ\text{C}$, a heat-resistant connection cable must be used.
- Batteries must not be installed in an explosion-proof enclosure.

1) Section 5.3 of GOST IEC 60079-1-2013

2) In accordance with table 3 of GOST IEC 60079-1-2013

7. Information on installation and ... / 8. Safety instructions

- Capacitors with a residual energy \geq mJ at the end of the time interval required to open the enclosure must not be installed in an explosion-proof enclosure. The enclosure must not be opened during operation.
After disconnecting the power supply, the enclosure may be opened not earlier than after minutes
- Installation with metal connection heads
The head must be grounded to prevent exposure to electromagnetic fields and electrostatic discharge. It does not need to be connected separately to the equipotential bonding system. It is sufficient that the metal thermowell has permanent and reliable contact with the metal tank, its components or pipework connected to the equipotential bonding system
- Neither repairs nor structural modifications are permitted, and any would void the guarantee and the respective certification.
- The manufacturer shall not be responsible for constructional modifications after delivery of the instruments.

EN

8. Safety instructions

8.1 Explosion protection designation

Design	Explosion-proof fitting
Solid-machined thermowell min. wall thickness mm	No
Solid-machined thermowell (min. wall thickness 1 mm)	Yes
Welded thermowell min. wall thickness mm	Yes
Without thermowell	Yes

See valid certificate TRTS012/2011

Electrical parameters

$U_m = DC 30 V$

$P_m = 2 W$

8. Safety instructions

8.2 Specific conditions for safe use (X conditions)

1. Ambient temperature limits:

T6: -60¹⁾/-50¹⁾/-40 ... +60 °C

T5: -60¹⁾/-50¹⁾/-40 ... +75 °C

T4...T1: -60¹⁾/-50¹⁾/-40 ... +80 °C

- Measures must be taken to ensure that heating or cooling caused by external sources does not cause the entire thermometer assembly to exceed the permissible operating temperature.
- All cable entries must be certified and compatible with the type of protection used.
- For Ex d IIC Gb: The nipples, union nuts and/or connectors used for the sensor connections must have appropriate Ex d certificates and must be compatible with the equipment class indicated in its marking. The maximum length of nipples must be ≤ 15.24 cm (6").
- For Ex tb: Nipples, union nuts and/or connectors used for sensor element connections must ensure that the entire thermometer assembly has the required ingress protection class.
- For temperatures above 70 °C, select a cable that is suitable for use in the required ambient temperature range.

1) optional version

8.3 Ensuring the explosion protection of the instrument

The explosion protection of the instrument (Ex d explosion protection) is ensured by enclosing the electrical parts in a explosionproof enclosure which withstands the pressure of an explosion and prevents the transmission of the explosion to the surrounding explosive atmosphere.

8.4 Requirements for ensuring that the specifications of the explosion-proof equipment are maintained

- During operation, storage and transport, the instruments must not be exposed to mechanical, chemical and other influences that can compromise the tightness of the housing, the condition of cables and cable entries, and cause damage to the insulation.
- Modifications to the instrument design are not allowed!
- Explosion-protected version of "Ex d" instruments must be visually inspected by the personnel in charge at regular intervals, at least once every 3 months.

During inspection, ensure that:

- there are no changes or deviations from the normal condition of the equipment;
 - the cable entry is undamaged;
 - unused cable entries are provided with plugs, seals are undamaged, the cover of the housing is tightened all the way;
 - all bolts required by design are present and properly tightened;
 - the label with the explosion protection marking is present as well as the warning notice indicating that the cover must not be opened when the instrument is energised.
- When operating the explosion-protected version of "Ex d" instruments, it is not allowed to:
 - open the enclosure of the instrument whose live parts are energised;
 - carry out any work on an instrument which is energised;
 - operate the instrument if its enclosure is damaged.

8. Safety instructions

EN

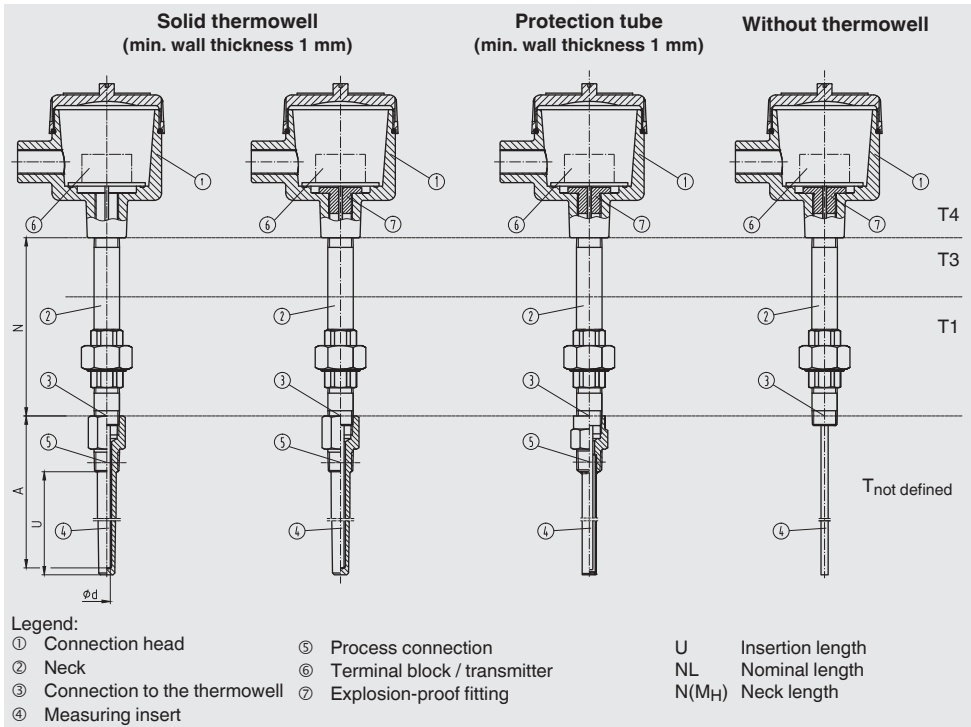

Temperature class classification, ambient temperatures

The connection head may become hot due to a malfunction of the built-in transmitter. The permissible ambient temperature depends on the connection head used and whether there is an additional transmitter built into the head.

The following ratios apply to all WIKA connection heads with built-in WIKA transmitters:

The temperature increase on the surface of the connection head or housing is less than 25 K if the following conditions are observed: power supply U_B maximum DC 30 V when the transmitter is operated in a current limit of 22.5 mA.

These conditions determine the following temperature classification:

Type of atmosphere	Temperature class	Temperature limits of the ambient temperature
Gas	T6	-60 ¹⁾ /-50 ¹⁾ /-40 ... +60 °C
	T5	-60 ¹⁾ /-50 ¹⁾ /-40 ... +75 °C
	T4...T1	-60 ¹⁾ /-50 ¹⁾ /-40 ... +80 °C
Dust	T80...T440 °C	-60 ¹⁾ /-50 ¹⁾ /-40 ... +60 °C

8. Safety instructions / 9. Maintenance and cleaning

The temperature class depends on the application and the ambient temperature. Permissible ambient temperature for third-party products can be found in the relevant regulations and/or data sheets. Nevertheless, unacceptable heat transfer from the process, which can result in exceeding the permissible housing temperature or temperature class, must be prevented by suitable thermal insulation or by using a neck tube in the design of the thermometer.

9. Maintenance and cleaning

9.1 Maintenance

The thermometers described in these operating instructions are maintenance-free.

Repairs must only be carried out by the manufacturer of the equipment.

9.2 Cleaning



CAUTION!

- Disconnect the electrical connections before cleaning them.
- Clean the instrument with a moist cloth.
- Electrical connections must not be exposed to moisture.
- To protect personnel and the environment from residual media, rinse or clean the dismantled instrument before returning it.
- Residual media in a dismantled instrument can result in a risk to personnel and the environment. Use personal protective equipment.



For information on returning the instrument, see section 11.2 "Return".

9.3 Calibration, recalibration

It is recommended that the measuring insert is calibrated at regular intervals (resistance thermometers: every 24 months, thermocouples: every 12 months).

This period can be shorter, depending on the particular application.

Calibration can be carried out both by the manufacturer of the equipment and by qualified technical personnel using calibrators.

10. Faults

10. Faults

EN

Faults	Causes	Actions
No signal/line break	Mechanical load too high or overtemperature	Replacement of the sensor or the measuring insert with a suitable version
Erroneous measured values	Sensor drift caused by overtemperature	Replacement of the sensor or the measuring insert with a suitable version
	Sensor drift caused by chemical attack	Use of a suitable thermowell
Erroneous measured values (too low)	Entry of moisture into cable or measuring insert	Replacement of the sensor or the measuring insert with a suitable version
Erroneous measured values and response times too long	Wrong mounting geometry, for example mounting depth too deep or heat dissipation too high	The temperature-sensitive area of the sensor must be inside the medium, and surfaces must be ungrounded
	Deposits on the sensor or thermowell	Remove deposits
Erroneous measured values (of thermocouples)	Parasitic voltages (thermal voltages, galvanic voltage) or wrong equalisation line	Check polarity Use of a suitable equalisation line
Indication of the measured value jumps	Cable break in connecting cable or loose contact caused by mechanical overload	Replacement of the sensor or measuring insert with a suitable design, for example fitted with strain relief or a thicker conductor cross-section
Corrosion	Composition of the medium not as expected or modified or wrong thermowell material selected	Analyse medium and then select a more-suitable material or replace thermowell regularly
Signal interference	Stray currents caused by electric fields or earth loops	Use of screened connecting cables, increase in the distance to motors and power lines
	Earth loops	Elimination of potentials, use of galvanically isolated transmitter supply isolators or transmitters



WARNING!

If the fault cannot be rectified by means of these measures, the instrument must be switched off immediately. Also check to make sure that there are no signals and take measures to ensure protection against unintended restart. Contact the manufacturer. If you need to return the instrument, follow the instructions in section 11.2.

List of critical failures:

1. The integrity of the housing is compromised.
2. The integrity of the cable insulation and/or cable entry is compromised.
3. The temperature measurement function is impaired.
4. Measuring deviation is outside the permissible limits.

11. Dismounting, return and disposal

11. Dismounting, return and disposal

EN



CAUTION!

Residual media in dismantled instruments can result in a risk to personnel, the environment and the equipment. Take sufficient precautionary measures.

11.1 Dismounting



CAUTION!

Risk of burns!

Allow the instrument to cool down sufficiently before dismantling it! During dismantling, there is a risk of sudden release of pressurised hot medium.

Only disconnect the thermometer once the system has been depressurised!

11.2 Return



CAUTION!

Before returning the instrument, carefully read the following information:

Any equipment sent to WIKA must be cleaned of hazardous media (acids, alkalis, solutions, etc.)

When returning the instrument, use the original packaging or suitable transport packaging.

To avoid any damage:

1. Wrap the instrument in an antistatic plastic film.
2. Place the instrument in a container with impact protection material.
Evenly distribute the impact protection material over the entire circumference of the container.
3. If possible, place a desiccant bag in the transport container.
4. Attach a warning label to the transport container, indicating that it contains highly sensitive equipment.



Information on the return procedure can be found in the “Service” section of the local website.

11.3 Disposal

Incorrect disposal may pose a risk to the environment.

Instrument components and packaging materials must be disposed of

